

Decorative Capitals For Round Columns

Marble Fiberglass Reinforced Polymer Composite Product Manufactured By Timeless Architectural Reproductions, Inc.™

14" Scamozzi

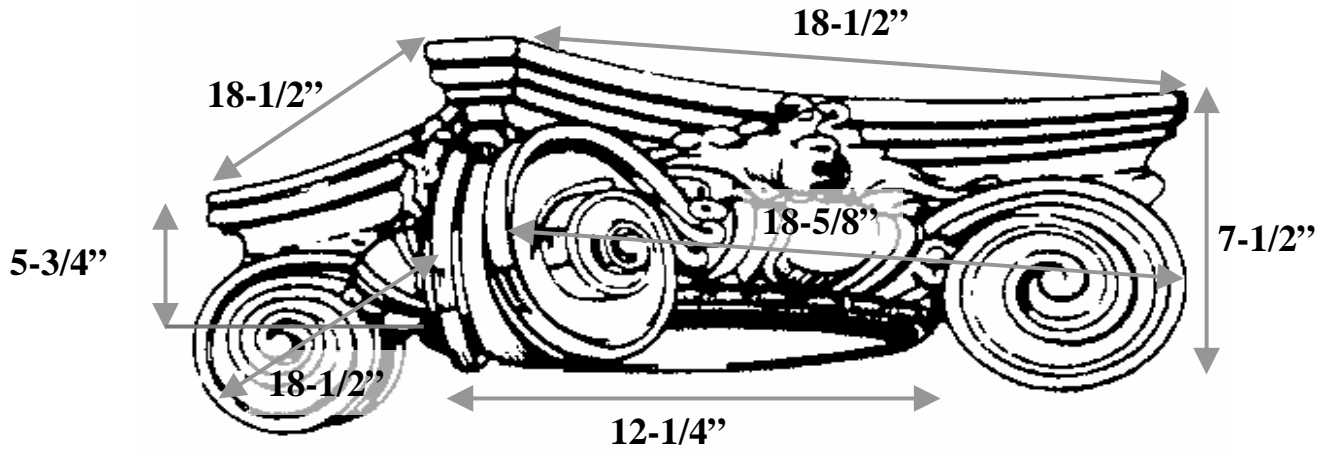

Item #	S14-29
Material	Resin and marble composite
Load Bearing	Yes
Product Weight	44 lbs
Shipping Weight	53 lbs
Base	12-1/4"
Inside Ring	7-1/8" (ring not shown)
Outside Ring	10-1/8"
Capital Height	5-3/4"
Abacus	18-1/2" x 18-1/2"
Scroll to Scroll	18-5/8" x 18-1/2"
Scroll Height	7-1/2"



TIMELESS ARCHITECTURAL REPRODUCTIONS, INC.™

Designers & Manufacturers of Classic Architectural Products

2655 Northgate Avenue
Cumming, GA 30041
(770) 205-1446 • (800) 665-4341 Office
(770) 205-1447 Fax
www.TimelessArchitectural.com

