

Decorative Capitals For Round Columns

Marble Fiberglass Reinforced Polymer Composite Product Manufactured By Timeless Architectural Reproductions, Inc.™

12" Scamozzi

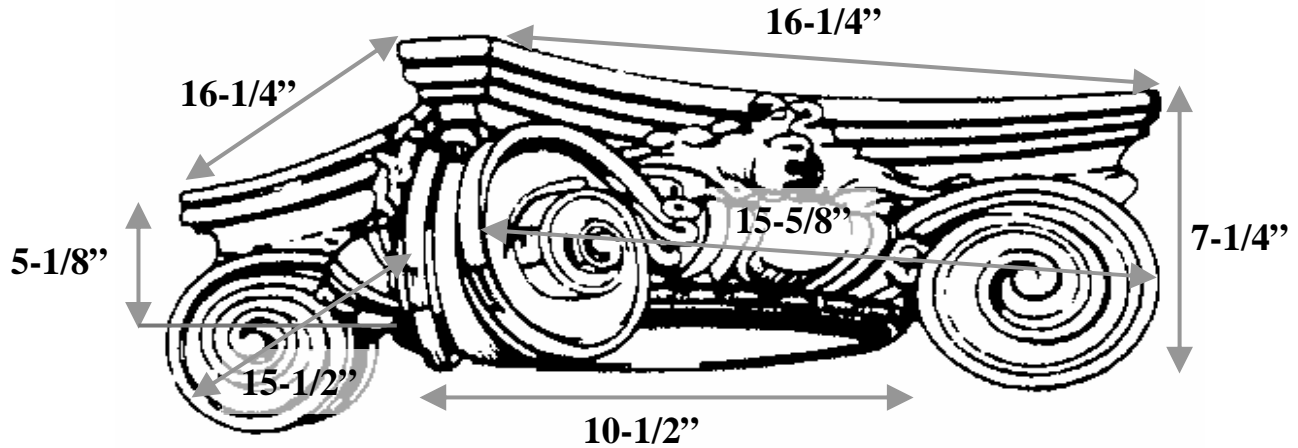

Item #	S12-38
Material	Resin and marble composite
Load Bearing	Yes
Product Weight	29 lbs
Shipping Weight	36 lbs
Base	10-1/2"
Inside Ring	5-3/8" (ring not shown)
Outside Ring	7-1/4"
Capital Height	5-1/8"
Abacus	16-1/4" x 16-1/4"
Scroll to Scroll	15-5/8" x 15-1/2"
Scroll Height	7-1/4"



TIMELESS ARCHITECTURAL REPRODUCTIONS, INC.™

Designers & Manufacturers of Classic Architectural Products

2655 Northgate Avenue
Cumming, GA 30041
(770) 205-1446 • (800) 665-4341 Office
(770) 205-1447 Fax
www.TimelessArchitectural.com

