

Decorative Capitals For Round Columns

Marble Fiberglass Reinforced Polymer Composite Product Manufactured By Timeless Architectural Reproductions, Inc.™

8" Scamozzi

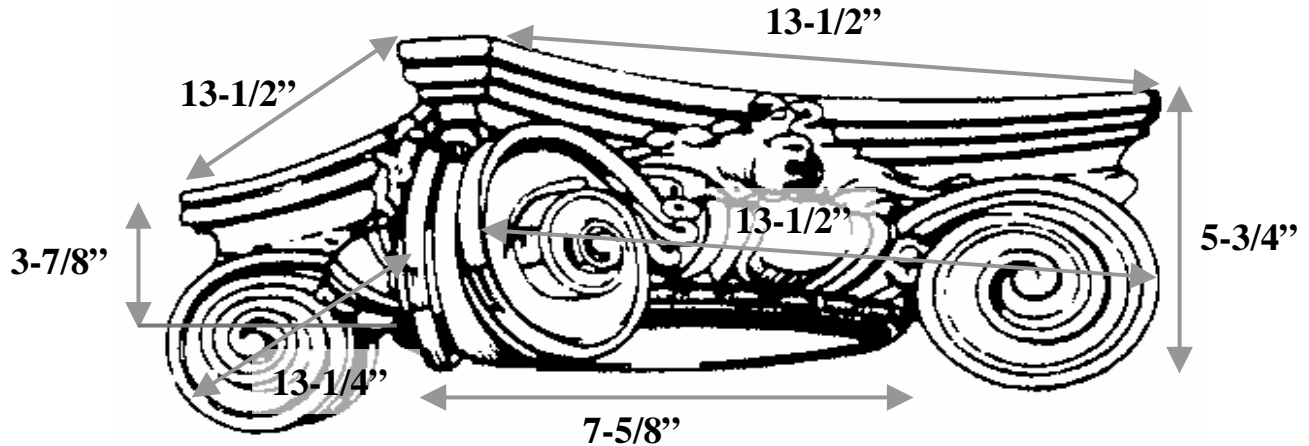

Item #	S08-34
Material	Resin and marble composite
Load Bearing	Yes
Product Weight	18 lbs
Shipping Weight	24 lbs
Base	7-5/8"
Inside Ring	2-3/4" (ring not shown)
Outside Ring	4-1/2"
Capital Height	3-7/8"
Abacus	13-1/2" x 13-1/2"
Scroll to Scroll	13-1/2" x 13-1/4"
Scroll Height	5-3/4"



TIMELESS ARCHITECTURAL REPRODUCTIONS, INC.™

Designers & Manufacturers of Classic Architectural Products

2655 Northgate Avenue
Cumming, GA 30041
(770) 205-1446 • (800) 665-4341 Office
(770) 205-1447 Fax
www.TimelessArchitectural.com

