

Decorative Capitals For Round Columns

Marble Fiberglass Reinforced Polymer Composite Product Manufactured By Timeless Architectural Reproductions, Inc.™

6" Scamozzi

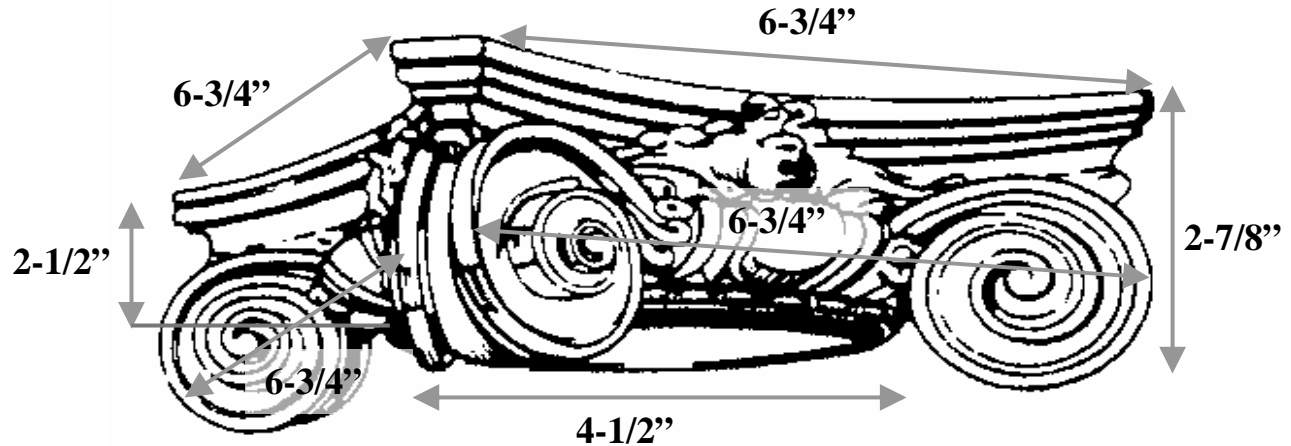

Item #	S06-93
Material	Resin and marble composite
Load Bearing	Yes
Product Weight	4 lbs
Shipping Weight	7 lbs
Base	4-1/2"
Inside Ring	1-7/8" (ring not shown)
Outside Ring	2-1/2"
Capital Height	2-1/2"
Abacus	6-3/4" x 6-3/4"
Scroll to Scroll	6-3/4" x 6-3/4"
Scroll Height	2-7/8"



TIMELESS ARCHITECTURAL REPRODUCTIONS, INC.™

Designers & Manufacturers of Classic Architectural Products

2655 Northgate Avenue
Cumming, GA 30041
(770) 205-1446 • (800) 665-4341 Office
(770) 205-1447 Fax
www.TimelessArchitectural.com

