

A Timeless
Product
Specification
Publication

Timeless

The Jefferson Collection

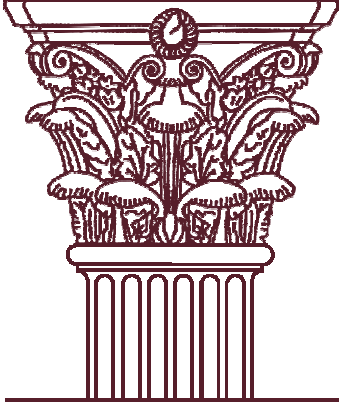

Residential Applications

The Jefferson Collection

Installations

Porches
Decks
Balconies
Porticos
Rooftops

Applications

Straight
Radius
Stairs

Balustrade Systems can be installed to

Brick
Stone
Concrete
Wood
Composite Decking
Columns
Any Siding

PRODUCT SPECIFICATIONS	4" Sphere Code ¹ Spacing	Common Spacing ² [non-code]
Rail System Height ³	37-3/8"	37-3/8"
Spacing	2"	3-5/8"
Spacing on Center	7-5/8"	9-1/4"
Balusters Needed per Linear Foot [LF]	1.573	1.3
Weight LF Baluster, Rail & Hardware	99 lbs.	88 lbs.
Weight Baluster	41 lbs.	41 lbs.
Weight Extended Baluster	52 lbs.	52 lbs.
Weight LFTall Profile Top Rail (RT301)	14.5 lbs.	14.5 lbs.
Weight LFTall Profile Bottom (RB305)	17.5 lbs.	17.5 lbs.
Weight LF Short Profile Top Rail (RT501)	9.5 lbs.	9.5 lbs.
Weight LF Short Profile Bottom Rail (RB505)	13 lbs.	13 lbs.

Customers are responsible for local code adherence.

¹ 4" Sphere Code spacing requires that a 4" ball cannot fit through any spacing between balusters.

² Common [non-code] spacing can be used in non-access applications or when spacing codes are not required.

³ Building codes for residential installations of balusters are typically specified at 36" in height.

BALUSTERS

Straight Applications

Straight or Stair Applications

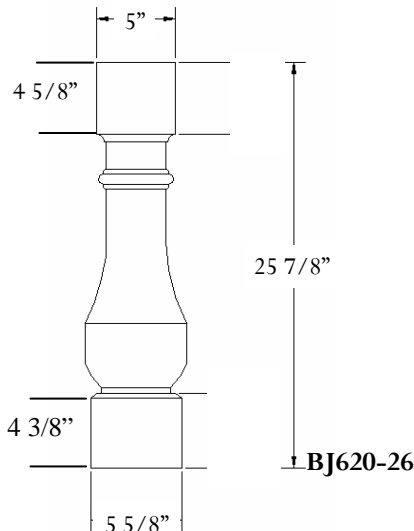

**New
Product
Image
Available
Soon**

BJ620-26

BJ620-32X

The Jefferson Residential Collection

CODE & HEIGHT CONSIDERATIONS

In some locales the Residential Building Code may require a balustrade height of greater than 36". In these instances the Extended height balusters and Newel Posts may be necessary.

It is the customer's responsibility to determine and meet all applicable building codes.

SHORT PROFILE RAIL OPTION

Jefferson Extended Balusters with the Short Profile Top Rail (RT-501) and the Short Profile Bottom Rail (RB-505) will meet most residential height requirements.

*** Short Profile Railings will NOT meet Residential Code height of 36" unless used with Jefferson Extended Balusters.**

RAILINGS

Tall Profile Railing

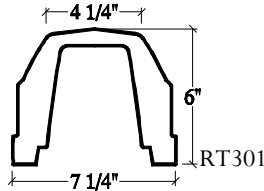

Top Rails

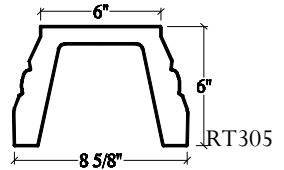

Bottom Rails

Short Profile Railing

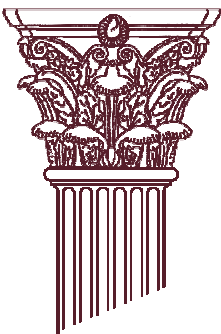
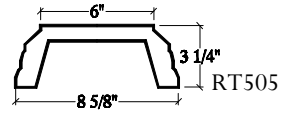
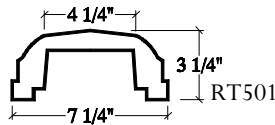

Timeless Architectural Reproductions, Inc.®

Designers & Manufacturers of Classic Architectural Products
2655 Northgate Avenue ♦ Cumming, Georgia 30041

Toll Free 800.665.4341 Phone 770.205.1446
Fax 770.205.1447

For more information about Timeless products, visit our web site

www.TimelessArchitectural.com

